



iCon - Intelligent Control for Heating Systems

iCon

Installation Manual

Title Page

© 2006 Comeragh Controls Ltd

No part of this document may be reproduced by any process without the prior written permission from Comeragh Controls Ltd.

The information in this document is provided for reference only. While every effort has been made to make sure it is accurate and complete, Comeragh Controls Ltd does not accept any liability arising out of the application or use of the information or products described herein. Moreover, Comeragh Controls Ltd reserves the right to alter specifications or procedures without notice.

This document may contain or refer to information or products protected by copyright or patents and does not convey any license under the patent rights of Comeragh Controls Ltd nor the rights of others.

All products referred herein are trademarks of their respective owners.

Publication details:

Title: iCon Heating Control System - Installation Manual

Issue: Ver 12.4.3

Valid up to System software release 12.4.11

Issue Date: 6-7-07

Part Number: CC-IconIM

Produced by:

Product Support Department

Comeragh Controls Ltd

Upper Irish Town

Clonmel

Co. Tipperary

WARNING!

DO NOT ATTEMPT TO INSTALL THE ICON WITHOUT SWITCHING OFF THE ELECTRICAL SUPPLY.

A QUALIFIED ELECTRICIAN AND/OR PLUMBER SHOULD CARRY OUT INSTALLATION OF THE ICON.

POWER MUST BE DISCONNECTED BEFORE OPENING THE I/O CONTROLLER ENCLOSURE



iCon - Intelligent Control for Heating Systems

TABLE OF CONTENTS

1. Introduction	4
1.1 Scope	4
1.2 Purpose	4
1.3 Product Description.....	4
1.4 System Components.....	4
2. System Wiring	5
2.1 Communication Wiring.....	5
2.1.1 Communication Wiring Layout.....	5
2.1.2 Cable Type.....	6
2.1.3 Communication Connection – Pin Outs.....	6
2.1.4 Termination.....	6
2.2 Logic I/O Unit Wiring	7
2.2.1 I/ O Wiring (Rev 11)	7
2.2.2 Wiring a Logic Box with no Sensors or console	8
2.2.3 Wiring Inputs	8
2.2.4 Addressing I/O Module	9
2.2.5 Modulation Actuator Output	10
3. Engineering Mode	11
3.1 Accessing Engineering Mode	11
3.2 Output Relay Manual Override.....	12
3.3 Moving between I/O Logic Box 1- 8	12
3.4 Output - Relay Configuration.....	13
3.5 View Status of Inputs.....	18
4. Weather Compensation.....	19
Level 1: Roaming Thermostat External Probe Only.....	19
Level 2: Manifold Flow Control External Probe & 0-10v Modulating Actuator.....	20
5. Communication – Diagnostics Function	23
6. Parameter Edit – Diagnostics Function.....	24
7. Exit Engineering/ Diagnostic Mode.....	24
8. Programming Thermostat	25
8.1 Setting the Sensor Type (At Console).....	25
8.2 Setting the Zone Number	26
8.3 Setting to I/O Pipe Stat.....	26
8.4 Setting to Exterior (For weather Compensation).....	26
8.5 Calibration.....	27
8.6 Attaching an External Probe	27
8.7 Stat Symbols	28



iCon - Intelligent Control for Heating Systems

8.7.1	Home Owner (Normal Mode) Icons	28
8.7.2	Stat Symbols - Engineering Mode Icons	29
9.	<i>Set Time</i>	30
10.	<i>Set Service Date</i>	30
11.	<i>Vacation Activation</i>	31
11.1	Setting Vacation Date in Console	31
11.2	Activating Vacation Through Phone.....	32
	Wiring Phone Activation.....	32
12.	<i>Connecting PC to a RS485 Serial Adaptor</i>	33
13.	<i>System Download</i>	35
14.	<i>System Reset</i>	35
15.	<i>System Erase</i>	35



iCon - Intelligent Control for Heating Systems

1. Introduction

1.1 Scope

The scope of this document covers the installation of the iCon Heating Control System.

1.2 Purpose

The purpose of the document is to provide the relevant information to enable the distributor install the iCon Heating Control System.

1.3 Product Description

The *iCon* is a complete heating & hot water management system. The system controls energy sources such as a boiler, geothermal pump, and solar panels through to energy exchangers such as underfloor heating, radiators and hot water cylinder in a single package. Management is from a central console, which schedules up to 32 zones.

1.4 System Components

The system comprise of the following components

System Component	Model Number	Description
Console	CC757	The Console is the central point of control and programming.
Thermostat	CC762	Serial Thermostats monitor temperature in a zone and communicate over a wired serial network.
I/O Controller or, Logic Controller	CC771	The I/O Controller is the wiring point to all pumps, 2 port valves, actuators etc.

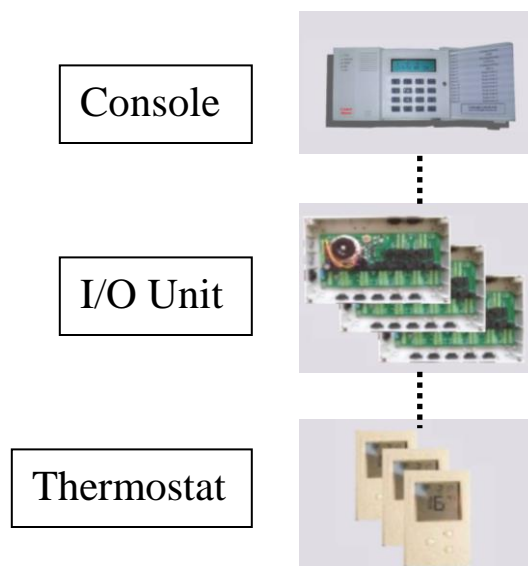



iCon - Intelligent Control for Heating Systems

2. System Wiring

2.1 Communication Wiring

2.1.1 Communication Wiring Layout

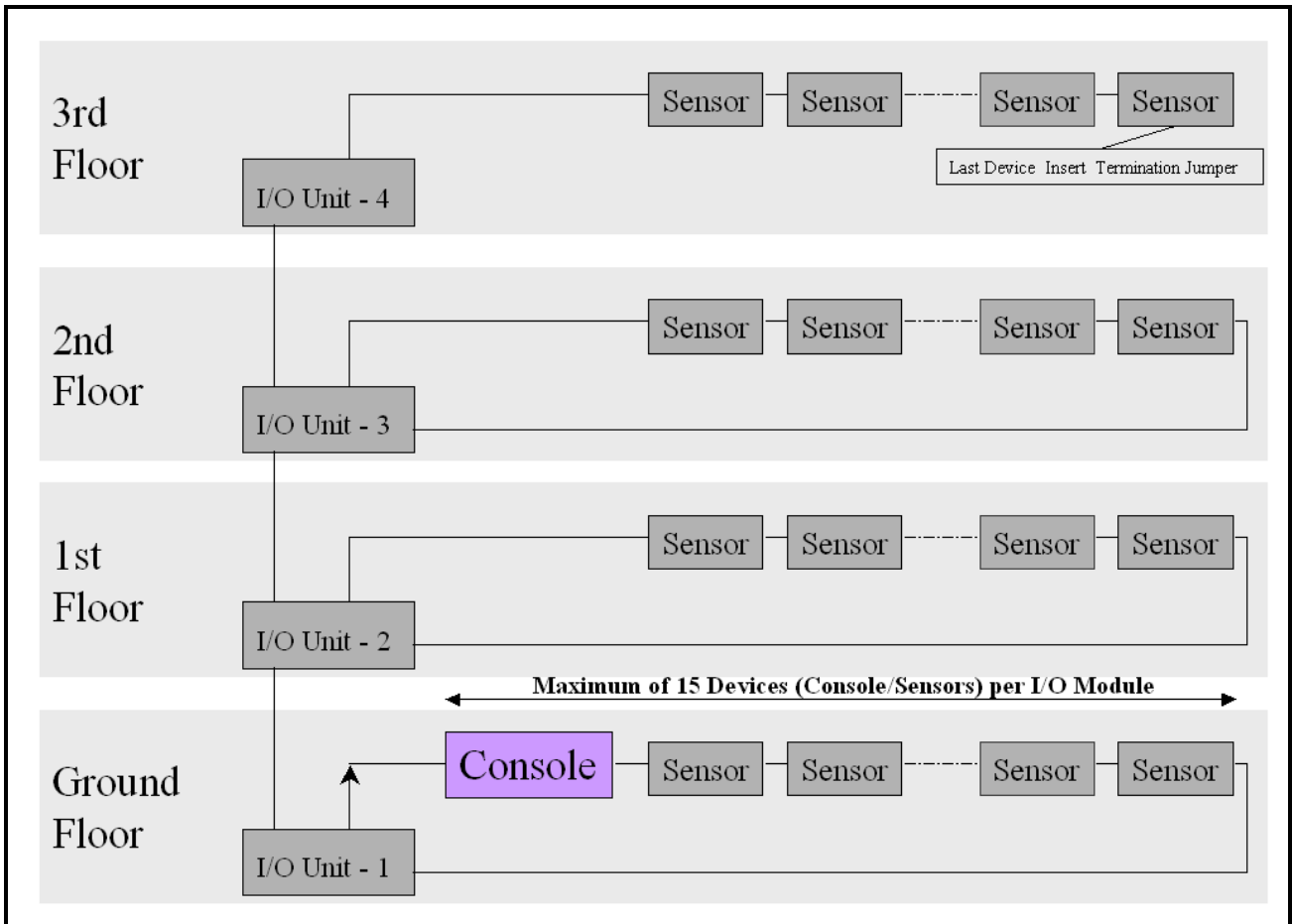

Notes:

- ❖ Maximum of 15 Devices (Console / Sensors) per I/O Module
- ❖ Last Device Insert Termination Jumper



iCon - Intelligent Control for Heating Systems

2.1.2 Cable Type

0-250 meter installations - Domestic Applications)

Cable Type	General Data Cable
Number Of Cores	4
Core Strands	7 / 0.2
Cable O-D	3.4mm
Conductor Material	Tinned Copper

Reel Length	RS Stock no.
100 Meter	365-571
500 Meter	365-600

250 –1500 meter installations - Commercial Applications)

Cable Type	RS422 / RS485 Data Cable
Number Of Cores	4
Core Strands	7 / 0.2
Cable O-D	3.4mm
Conductor Material	Tinned Copper

Reel Length	RS Stock no.
500 Meter	528-2178

Supplier

RS Components

Web: www.rswww.com

Tel: UK Orderline: 08457 201201

Tel: UK Online Help: 01536 444222

2.1.3 Communication Connection – Pin Outs

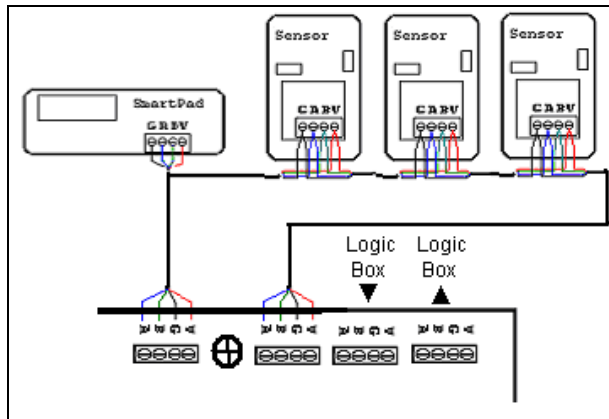

2.1.4 Termination

Last Device - Insert 120 ohm Termination Jumper

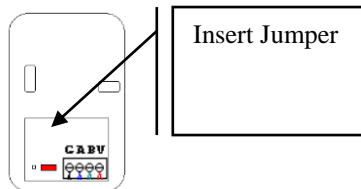

2.2 Logic I/O Unit Wiring

2.2.1 I/ O Wiring (Rev 11)

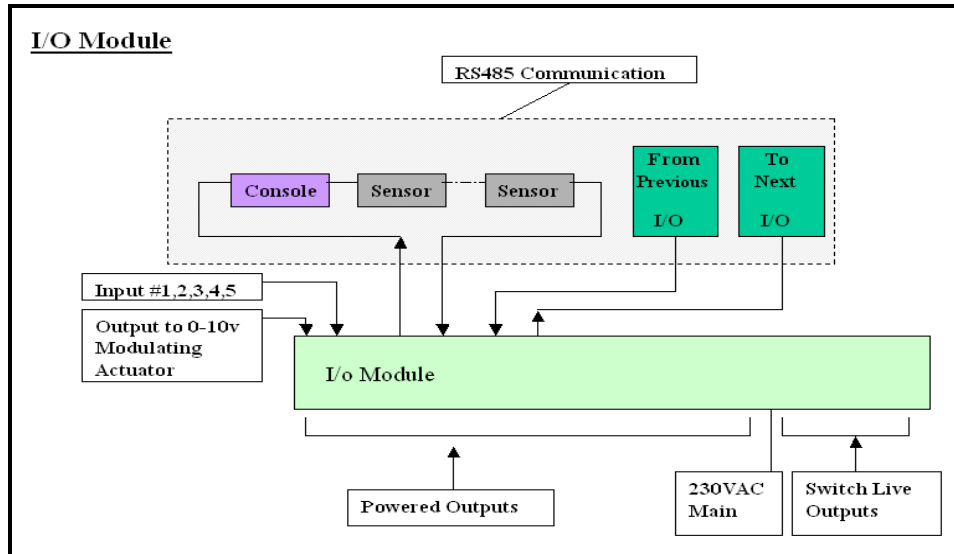

Powered Outputs	Output Voltage	220v AC or 24 v AC
	Fuse	Pairs
	Max Load	2 Amps
	Terminations Per Relay	3
Switch Live	Max Load	4 Amp
	Facility to convert to Individual Powered Outputs	Yes
Inputs	Type	Volt Free
	Satisfied (Short Circuit)	S/C
	Not Satisfied (Open Circuit)	O/C
Modulation Actuator Output (0-10v)	Output	0-10v
	Supply	24v AC (+/- 10%)
	Max Supply Load	3 Watts
Communications	Communications	RS485
	Range	1500 M
	Max qty linked to a console	1 to 8
Supply Voltage	Supply Voltage / Frequency	220v AC (50/60 Hz)
	Fuse (Slow Blow)	1Amp
Dimensions (In mm)		D (60), L 300, H 200
LED Indicators		Yes
Boiler Interlock		Yes

2.2.2 Wiring a Logic Box with no Sensors or console

If no console or sensor connected to a logic box the RS485 network connection must be jumper

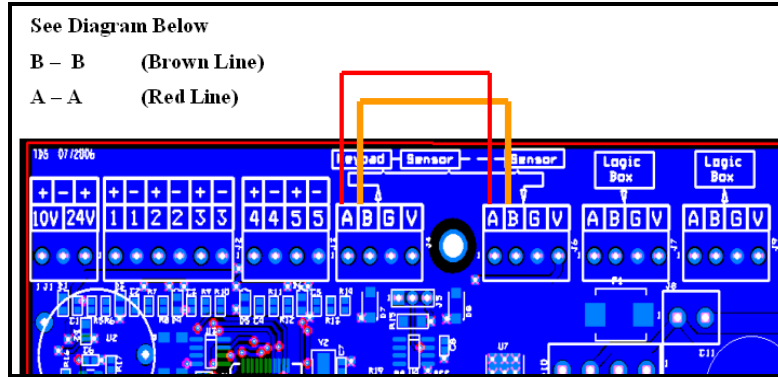

2.2.3 Wiring Inputs

Input on Logic Board

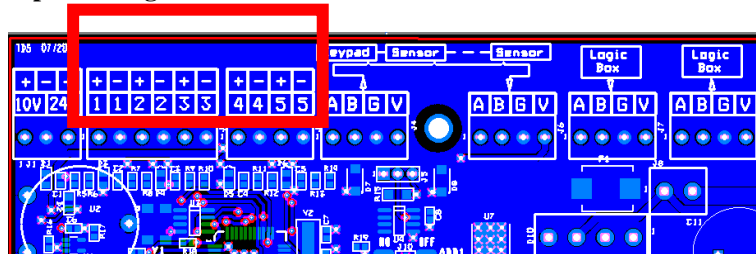

Comments

All inputs must be VOLT FREE

Operation

Inputs can be use at Activation, Overrides or Enables

Input are operate similar to stat

Example:

Input signal from cylinder stat is used to overriding a pump, lets use input I on Logic Box 1 (I1:1)

If the cylinder is not satisfied the input should be short circuited (e.g. input [1+] [1-] joined)

When the cylinder is satisfied the input should go open circuit (e.g. input [1+] [1-] unconnected)

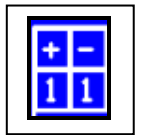

Summary

Call for Heat = Short Circuit

Satisfied = Open Circuit

Technical Comment

The logic board set the input High (+5v).

If Open Circuit or nothing attached the input are activate

If Closed Circuit the input is de-activate (Satisfies)

2.2.4 Addressing I/O Module

I/O Addressing (Rev 11)

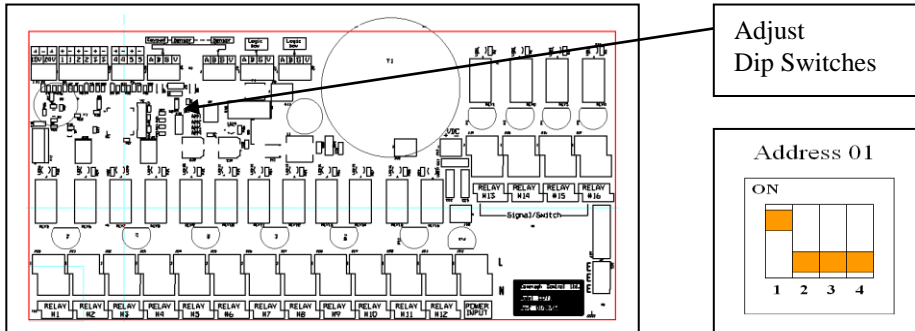

Dip Switch Table

Logic Box Number	Dip Switch Settings			
	1	2	3	4
1	ON	OFF	OFF	OFF
2	OFF	ON	OFF	OFF
3	OFF	OFF	ON	OFF
4	OFF	OFF	OFF	ON
5	ON	OFF	OFF	ON
6	OFF	ON	OFF	ON
7	ON	ON	OFF	ON
8	ON	OFF	ON	ON

iCon - Intelligent Control for Heating Systems

2.2.5 Modulation Actuator Output

Overview: Weather Compensation Facility via 0-10v output

Software algorithms compare the External Temp, Max External Temp, Max Flow Temp, Min Flow Temp and derive the required flow temp and the desired flow temp is achieved by regulating the flow temp via the 0-10v output.

This output regulates a Modulating Actuator on the manifold. (Modulating Actuator not included)
The system is Self-Compensating via a manifold pipe stat.

Specifications

Supply Output	24v AC ($\pm 10\%$)
Max Load	3 Watt
Modulation Output	0v 10v DC

Connections

Outline below are the relevant connection

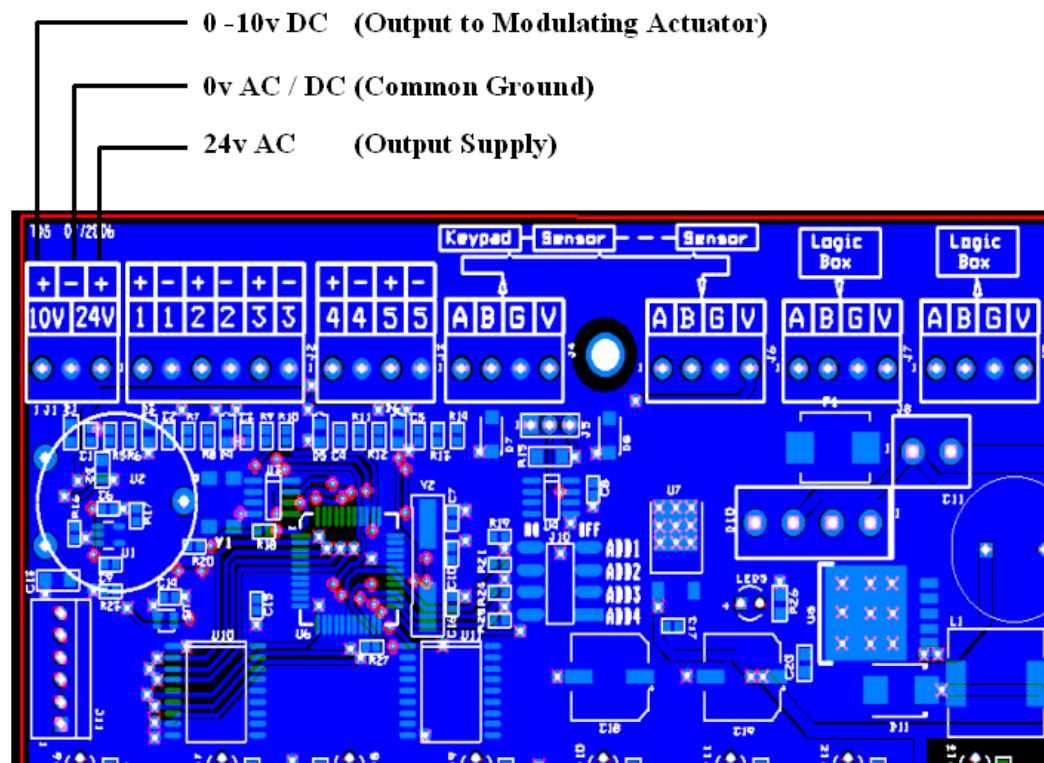



iCon - Intelligent Control for Heating Systems

3. Engineering Mode

3.1 Accessing Engineering Mode

Press **MODE** & **HOME** together.

Enter the Engineering Code **3105** & Press

Console Displays the following **0000000111111100**
St34567890 [1/01]

Press **TIME** to move between the following fields

Output Status → **0000000111111100**
St34567890 [1/01]

To move through relays press and
Press the to Activate or Deactivate a relay
See Section: 3.2 Output Relay Manual Override

Time On Delay → **1407000000000000**
To34567890 [1/01]

To move through relays press and
Press the to set the Time On Delay
1=1 Min. 2=2 Min. 3=3 Min99 = 99 Min

Time Off Delay → **1407000000000000**
Tf34567890 [1/01]

To move through relays press and
Press the to set the Time Off Delay
1=1 Min. 2=2 Min. 3=3 Min99 = 99 Min

Relay Output Configuration **Z T**
1 [1/01]

Description detailed in following section
3.4 Output - Relay Configuration

View Status of Inputs **11000**
12345

Description detailed in following section
3.5 View Status of Inputs





iCon - Intelligent Control for Heating Systems

3.2 Output Relay Manual Override

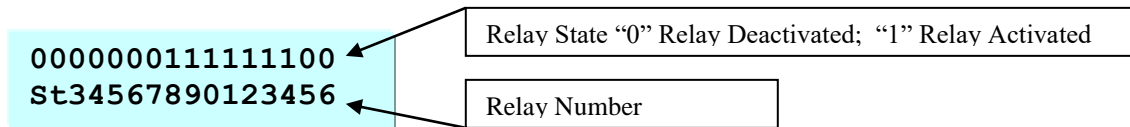
The I/O Module Output Status Window displays the state of each the relay output.



To move through relays press  and 

Press the  to Activate or Deactivate a relay

3.3 Moving between I/O Logic Box 1- 8

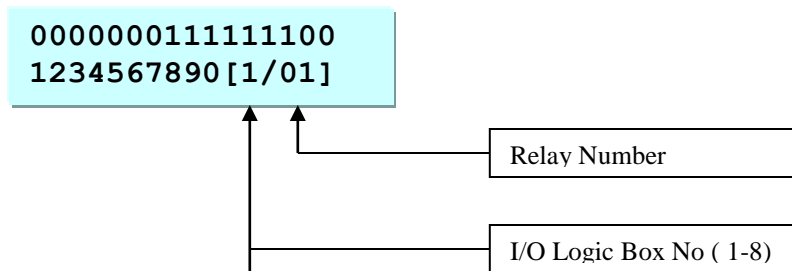

Press  to toggle between I/O logic box 1-8



iCon - Intelligent Control for Heating Systems

3.4 Output - Relay Configuration

Press **TIME** to move to configuration mode

Console Displays similar to the following

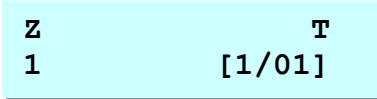

Each relay can be Activated & De- Activated by multiple factors

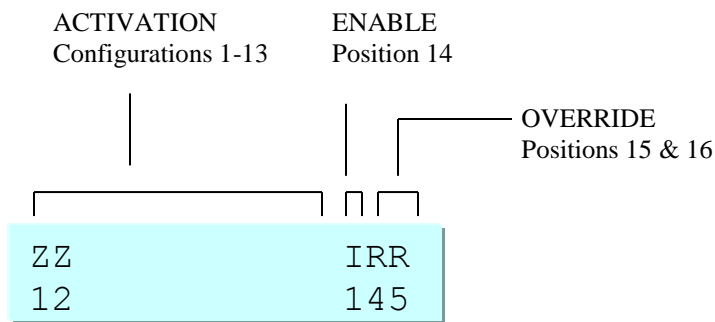

Each output relay is activated by any one of 13 possible configuration type states.
Each output relay is also enabled by 1 possible configuration type states.
Each output relay is also Overridden by 2 possible configuration type states.

Step 1 – Select Relay

Select the Relay to be configured

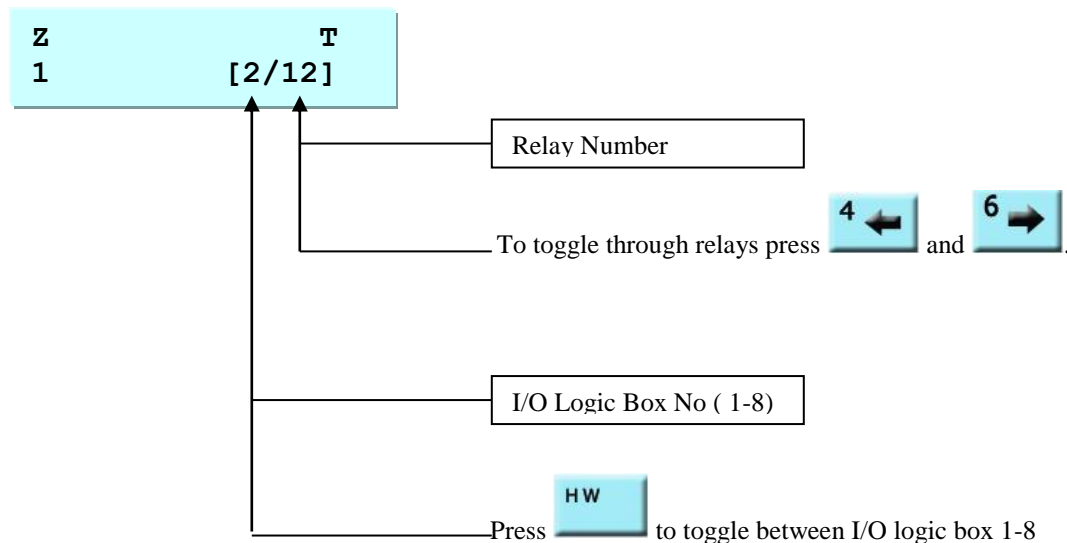



iCon - Intelligent Control for Heating Systems

Step 2 – Relay Activation

A relay can be configured to Activate/Enabled/Overridden in response to a number of factors.

Press  to select the factor.

	Factors
Z	Below Zone Calling for Heat
I	Input
R	Another Relay
E	DHW Energy Saver Threshold – Follows Zone Schedule
S	DHW Set Point Threshold – No Schedule – Activated below SP
C	Hi Cylinder Stat – No Schedule – Activated above SP
H	Relay activated by HW Boost Key
T	Relay activated by a another Relay Including Timer
M	Mixer activate
A	Air Conditioning (Cooling)

Z - Relay activated by a Zone

Press  to toggle through the zone numbers .
(Note 32 Zones)

Z
2~4 [1/01]

Press  to store the desired zone.
As there can be up to 32 zones per logic box,
when the zone number is 10 – 32 the display will flash
between both digits. I.e. Zone 24 displays as a flashing 2 then 4

Z
2 (Appears for 1 Sec =20)
4 (Appears for ½ Sec = 4)
Actual Zone 24

I - Relay activated by an Input

Press  repeatedly to select the factor - I.

Press  to toggle through the Input numbers.
(Note: 3 Inputs per Logic Box)

Press  to select the correct logic box.
(Display alternated between I & Logic Box No. 1,2,3)

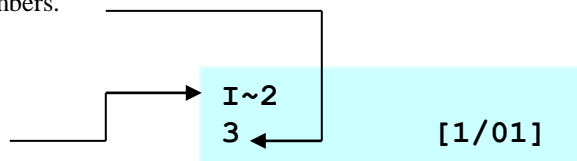

R - Relay activated by a another Relay

Press  repeatedly to select the factor - R.

Press  to toggle through the Relay numbers.
(Note: 16 Relay per Logic Box)

Press  to select the correct logic box.
(Display alternated between R & Logic Box No. 1,2,3)

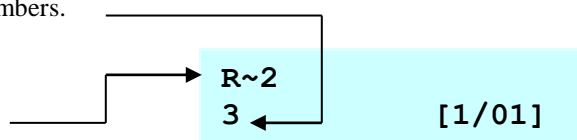



iCon - Intelligent Control for Heating Systems

E - DHW Energy Saver Threshold – Follows Zone Schedule

Press  repeatedly to select the factor - D.

Press  to toggle through the zone numbers .

E
7 [1/01]

S - DHW Set Point Threshold – No Schedule – Activated below SP

Press  repeatedly to select the factor - S.

Press  to toggle through the zone numbers

S
7 [1/01]

C - Hi Cylinder Stat – No Schedule – Activated above SP

Press  repeatedly to select the factor - C.

Press  to toggle through the zone numbers

C
7 [1/01]

H- Relay activated by HW Boost

Press  repeatedly to select the factor - H.

H
[1/01]



iCon - Intelligent Control for Heating Systems

T - Relay activated by a another Relay Including Timer

Press  repeatedly to select the factor - T.

Press  to toggle through the Timed Relay numbers.
(Note: 16 Relay per Logic Box)

Press  to select the correct logic box.
(Display alternated between R & Logic Box No. 1,2,3)

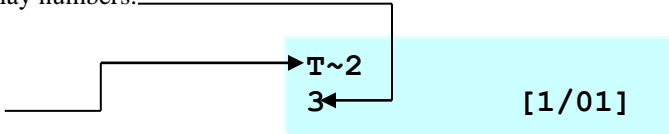

M - Relay activated when Mixer is activate

Press  repeatedly to select the factor - M.

Press  to select the correct logic box.
(Display alternated between R & Logic Box No. 1,2,3)

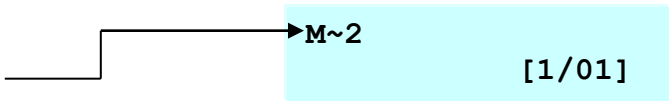

A - Relay activated by a Zone in Air Conditioning (Cooling)

Press  repeatedly to select the factor - A

Press  to toggle through the zone numbers .
(Note 32 Zones)

Press  to store the desired zone.
As there can be up to 32 zones per console, when the zone number is 10 – 32 the display will flash between both digits. I.e. Zone 24 displays as a flashing 2 then 4

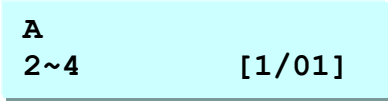
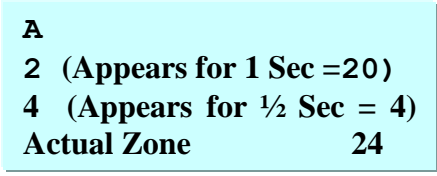
NOTE: Each output can be activated by up to 13 factors, Enabled by 1 factors and Over-ridden by 3 factors.

To enter the next factor press  and repeat the steps above.

[Activation (13)] [Enable (1)] [Override (2)]





iCon - Intelligent Control for Heating Systems

Step 3 – Relay Enable

Each output relay can be enabled by 1 possible configuration type states.

Press **9** until you reach the 3rd last field

Press **7** to sep back if you move too far

Press **1** repeatedly to select the factor - Z.

Press **2** to toggle through the factor numbers.
(e.g. Z,I,R,D,T,H)

Press **3** to select the correct logic box.
(Applied only to Inputs & Relays)

ENABLE
Position 14

Z R 7

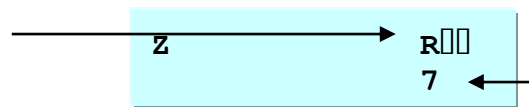

Step 4 – Relay Override

Each output relay is also over-riden and deactivated by 2 possible configuration type states.

Press **9** until you reach the last 2 fields

Press **7** to sep back

Press **1** repeatedly to select the factor - R.

Press **2** to toggle through the factor numbers.
(e.g. Z,I,R,E,S,C,H,T,M,A)

Press **3** to select the correct logic box.
(Applied only to Inputs & Relays)

Z IT 1

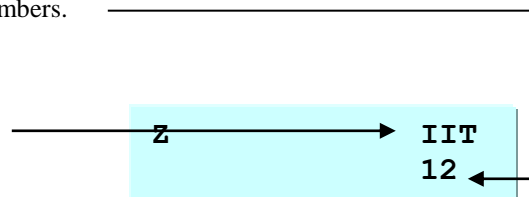



iCon - Intelligent Control for Heating Systems

3.5 View Status of Inputs

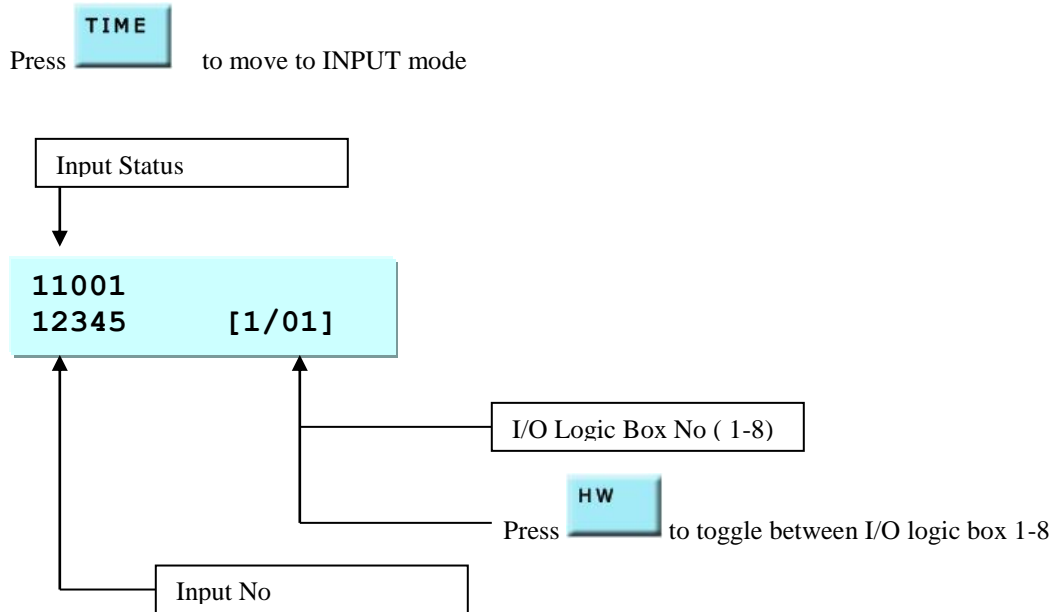

Any **Input** can be configured at programming stage to activate or deactivate any set of relays

Sample Configuration

- S1 – Heatpump is producing hot water. It is to be connected through a normally closed contactor to pin 15 on HP panel.
i.e. when hp is producing hot water S1 input is to be open
- S2 – Hot Water Cylinder Stat. is to be open when calling.
i.e. closes when temp. Is reached
- S3 – Heat Pump Help. It is to be connected through a normally closed contactor operated by pin 6 on HP panel.
When open 2nd heat source i.e. boiler and mixing pump should be called.



iCon - Intelligent Control for Heating Systems

4. Weather Compensation

Two levels of weather compensation are available

Level 1:	Roaming Thermostat	External Probe Only
Level 2:	Manifold Flow Control	External Probe & 0-10v Modulating Actuator

Level 1: Roaming Thermostat External Probe Only

4.1 Setting a Stat To External Stat

Overview:

By simply configuring a thermostat & probe to Et (External Temperature), the iCon system activates weather compensation automatically. The iCon system compares each room's temperature to the external temperature and depending on the situation initiates the required level of optimisation.

Configuring Steps:

1. System must be in Timer Mode
2. Attach an external probe to the stat.
3. Locate the probe's metal end outside the building
Note – Do not locate in Direct Sun Light, Shade, or Adjacent to Heating Vent
4. Configure a stat in the following manner.

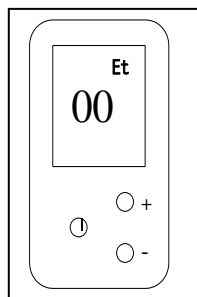



Image No. 1

Accessing Steps

Access Zone Setting Level

- a) Press and hold Power Button
- b) When 00 appears at TOP AND CENTER press buttons in the following sequence
 - Press  3 times
 - Press + 3 times
 - Press - 3 times
- c) Use the + and - Key to set the (ZN) Zone Number
Note Normally set Zone No to 00
However a Stat can be uses as both a Zone & External Stat
Simply set the Zone Number and complete the following steps
- d) Press and hold Power Button AGAIN– 00 & IO is displayed
- e) Press Power Button Again, Exterior Setting (Et) is displayed

Setting Steps

- f) Use + key to set to 01 (Sensor now set as exterior)

(Weather Compensation Activates Automatically)

(After 5 sec the stat time out and reverts back to normal)



iCon - Intelligent Control for Heating Systems

Level 2: Manifold Flow Control External Probe & 0-10v Modulating Actuator

Overview:

If modulating actuators are utilized within the heating system the iCon system will initiate Weather Compensation through Flow Temperature Control.

Flow Temp Control. Adjusts the manifold flow temperature via a 0-10 modulation actuator to achieve the desired flow temp.

Key Steps

Configuring thermostat & probe to Et (External Temperature) (Install probe externally) (See section 4.1)

Configuring a thermostat & probe to I/O (I/O Module address – Manifold number)(Attached probe to Manifold Flow)

- I/O – Enter the manifold address
- PT – Enter the max manifold flow temp
- FT – Enter the min manifold flow temp

Configuring Steps:

Step 1 System must be in Timer Mode

Step 2 Set up External Thermostat

- Attach an external probe to the stat.
- Locate the probe's metal end outside the building
Note – Do not locate in either Direct Sun Light, Shade, or Adjacent to Heating Vent
- Configure a stat in the following manner.

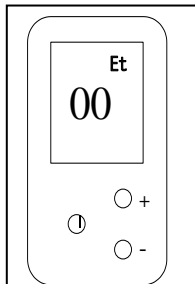

Accessing Steps

- Follow Sec 8.2 **Setting the Zone Number**
Press and hold Power Button Again, I/O Pipe stat address is displayed
Press Power Button Again, Exterior Setting (Et) is displayed

Setting Steps

- Use + key to set **Max External Temp.** e.g. 25° (Sensor now set as exterior)
(Weather Compensation Activates Automatically)

Note Zone address must be 00

Step 3 Set up Pipe Stat

1. Attach an external probe to the stat.
2. Clamp metal probe end to the manifold flow
3. Configure a stat in the following manner.

3.1 Set Stat's I/O Address

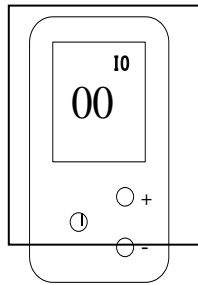

Accessing Steps

- a) Follow Sec 7.2 Setting the Zone Number
- b) Press and hold Power Button Again , I/O Pipe stat address is displayed

Setting Steps

- c) Use the “+” key to select the manifold number (address) (I/O Module Pipe Stat address)

3.2 Set Max Flow Temp (Pt- Pipe Temp)

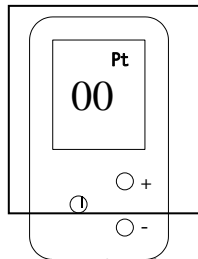

- d) Press Power Button again, PT (Pipe Temp) is displayed
- e) Use the “+” key to select the **Max Flow Temp** for this manifold.
(After 5 sec the stat time out and reverts back to normal)

Note Zone address must be 00

3.3 Set Min Flow Temp (Ft- Flow Temp)

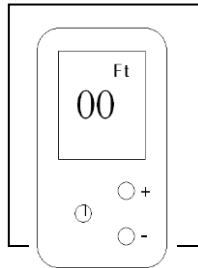

- f) Press Power Button again, Ft (Flow Temp) is displayed
- g) Use the “+” key to select the **Min Flow Temp** for this manifold.
(After 5 sec the stat time out and reverts back to normal)

Note Zone address must be 00

Operation:

If Pipe Temp is below Factory Set Min Flow Temp (22°)
 If Pipe Temp is above Max Flow Temp (Pt)
 If ΔT Between DFT & AFT >3 THEN
 If ΔT Between DFT & AFT <3 $\Delta T >2$ THEN
 If ΔT Between DFT & AFT <2 $\Delta T >.5$ THEN
 If ΔT Between DFT & AFT $<.5$ $\Delta T >.5$ THEN
 If the DFT is below the Installer set Min Flow Temp (FT)

Modulation Output set to 10v
 Modulation Output set to 0v
 Modulation Output increments or decrements by .8V
 Modulation Output increments or decrements by .4V
 Modulation Output increments or decrements by .2V
 Modulation Output -Remain at currant voltage
 Modulation Output increments by .8V

Notes:

DFT = Desired Flow Temp

AFT= Actual Flow Temp

Step 4 Attached 0-10v Modulating Actuator

Modulation Actuator Output

Overview: Weather Compensation Facility via 0-10v output

Software algorithms compare the External Temp, Max External Temp, Max Flow Temp, Min Flow Temp and derive the required flow temp and the desired flow temp is achieved by regulating the flow temp via the 0-10v output.

This output regulates a Modulating Actuator on the manifold. (Modulating Actuator not included)
The system is Self-Compensating via a manifold pipe stat.

Specifications

Supply Output	24v AC ($\pm 10\%$)
Max Load	3 Watt
Modulation Output	0v 10v DC

Connections

Outline below are the relevant connection

WARNING: Cables must be wired as show, failure to do so will result in the 0-10v port failure

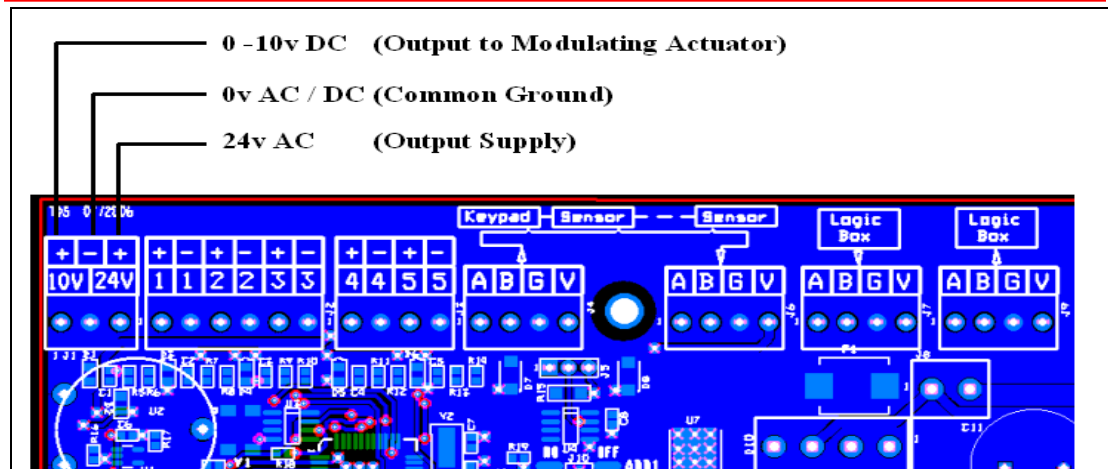

Step 5 Configuring a Zone Stat to be both a Zone Stat and Pipe Stat or External Stat

Overview:

To reduce the overall system cost a zone stat can be used as a Zone Stat and Pipe Stat or External Stat
The stat will not display ET(External Temp) or PT (Pipe Temp).
The stat will appear as a normal zone stat

Setup:

Follow steps outline in following

- a) **Set up External Thermostat**
- b) **Set up Pipe Stat**

Set the Zone address Number

Note: These Zone stat can only be configured as T1 (Air Temp)



iCon - Intelligent Control for Heating Systems

5. Communication – Diagnostics Function

Step 1 Access Engineering Mode

Press **MODE** & **HOME** together.

Enter the Engineering Code **3105** & Press

Console Displays the following

Step 2 Thermostats & I/O Communications

Thermostats Communications

Press **ZONE**
Console Displays the following ← These Represent Thermostat 1-31

The console automatically attempts to communicate with the thermostats, and displays a ? at each Zone ,

- ❖ If Communication is OK - * displayed ,
- ❖ If communication Error – The Zone number continuous to display.

← Stats 1234_67 are ok 5 not responding

Possible Communication Issues

- ❖ Check wiring - Ensure 12V, Gnd, A and B connections are not mixed up
- ❖ Check if correct Zone number is programmed into thermostat
- ❖ Check there are no duplications of Zone numbers

I/O Communications

Press to move to the I/O Communication
* = Communication OK
? = Communication Error

Console Displays the following ← 12345678 I/O Box address

To exit out of verify communications mode press **ZONE**





iCon - Intelligent Control for Heating Systems

6. Parameter Edit – Diagnostics Function

While in Engineering Mode – Press 

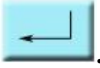
There are 4 parameters that may be edited:

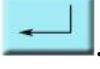
- ❖ User Password Edit & Press 
- ❖ Frost Protection Edit & Press 
- ❖ Minimum Temperature. Edit & Press 

7. Exit Engineering/ Diagnostic Mode

Press the  key to exit.



iCon - Intelligent Control for Heating Systems

8. Programming Thermostat

8.1 Setting the Sensor Type (At Console)

Overview: The thermostat can be configured to the following

At the Console enter the Zone Number & press 

Press 

Console displays

```
<NORML>    NORML
ZO1        LK OFF
```

Press  &  simultaneously

Console displays

```
< T1 >    NORML
ZO1        LK OFF
```

Press  &  to select T1,T2,T3,T4

<p>Default – Air temp Air</p>	<p>Type 1 (T1) (CH1)</p>	<p>[Air settings SP + SB+ BH]</p>
<p>Console displays</p>	<pre><SP20> SB06 BH02 ZO1</pre>	<pre>SP = Air Set Point SB = Air Set Back BH = Air Boost Heat</pre>
<p>External Probe Terminal Bathroom Probe, Screed etc</p>	<p>Type 2 (T2) (CH2)</p>	<p>[Setting SP + SB+ BH]</p>
<p>Console displays</p>	<pre><SP20> SB06 BH02 ZO1</pre>	<pre>SP = Probe Set Point SB = Probe Set Back BH = Probe Boost Heat</pre>
<p>Floor Surface Hi Limit Protection – Screed Max temps setting Air & Floor</p>	<p>Type 3 (T3) (CH1/CH2)</p>	<p>[Air settings SP + SB] & [Floor Hi Limit Safety Settings]</p>
<p>Console displays</p>	<pre><SP20> SB06 BH02 ZO1</pre>	<pre>SP = Air Set Point SB = Air Set Back BH = Air Boost Heat</pre>
<p>Note: The Screed High (SH) Limit value is set in the sensor Access the 2nd lever engineering mode in the sensor and set the “SH” Screed High Limit value to the required setting See Section: 8.7.2 Stat Symbols - Engineering Mode Icons</p>		
<p>DHW - Safety Feature, Installer set the Max temp DHW</p>	<p>Type 4 (T4) (CH2)</p>	<p>[Max +Min set by installer] & [SP set by home owner]</p>
<p>Console displays</p>	<pre><SP68> ES30 UP80 ZO1</pre>	<pre>SP = DHW Set Point ES = Energy Saver – Threshold level to switch to low cost energy source to generate DHW UP = DHW Upper Limit (Max Safety Limit)</pre>

8.2 Setting the Zone Number

Overview: Each area (room) must have a zone number

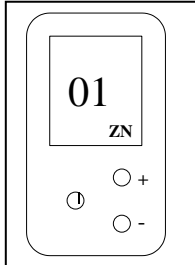



Image No. 1

Steps

- a) Press and hold Power Button
- b) When 00 appears at TOP AND CENTER press buttons in the following sequence
 - Press  3 times
 - Press + 3 times
 - Press - 3 times
- c) Use the + and - Key to set the (ZN) Zone Number
Note: Ensure that all zones are set correctly matching the console

8.3 Setting to I/O Pipe Stat

Overview: Manifold Stat **Type 5** (CH2) [I/O (Manifold) Stat]

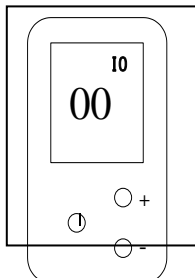

Image No. 2

Accessing Steps

- h) Repeat Steps for **Setting the Zone Number (See Section 8.2)**
- i) Press and hold Power Button Again , I/O Pipe stat address is displayed

Setting Steps

- j) Use the “+” key to select the manifold number (address) (I/O Module Pipe Stat address)
- k) Press Power Button again, PT (Pipe Temp) is displayed
- l) Use the “+” key to select the **Max Pipe Stat Flow Temp** for this manifold.
(After 5 sec the stat time out and reverts back to normal)

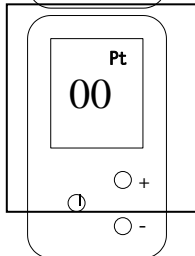

Image No. 3

8.4 Setting to Exterior (For weather Compensation)

Overview: Exterior Temp **Type 6** (CH2) [External Temp]

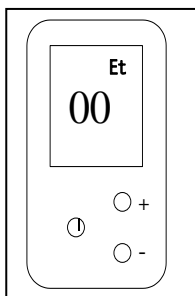

Image No. 4

Accessing Steps

- a) Repeat Steps for **Setting the Zone Number (See Section 8.2)**
Press and hold Power Button Again, I/O Pipe stat address is displayed
Press Power Button Again, Exterior Setting (Et) is displayed

Setting Steps

Level 1 Weather Compensation – External Probe Only

Use + key to set to 01 (Sensor now set as exterior)
(Weather Compensation Activates Automatically)

Level 2 Weather Compensation – External Probe & Modulating Actuator

Use + key set the desired Max External Temp (Sensor now set as exterior)
(Note Pipe stat must be configured & fitted on each manifold flow.)
(Weather Compensation Activates Automatically)
(After 5 sec the stat time out and reverts back to normal)

8.5 Calibration

Overview: Each thermostat can be calibrated up to a max of 3 degrees.

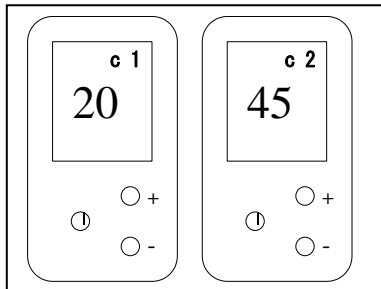

Image No. 5

Image No. 6

Steps

- a) See **Setting the Zone Number (See Section 8.2)** (Image No. 1)
 - b) Press and hold Power Button Again, I/O Pipe stat (Image No. 2)
 - c) Press Power Button Again, Exterior Setting (Et) (Image No. 3)
 - d) Press Power Button Again, Pipe Temp (Pt) (Image No. 4)
 - e) Press Power Button Again, c1 – Channel 1 –Air (Image No. 5)
 - f) Press Power Button Again, c2 – Channel 2 –Probe (Image No. 6)
- Use + and -keys to calibrate, Increments of .5° (Max of 3°)
(After 5 sec the stat time out and reverts back to normal)

8.6 Attaching an External Probe

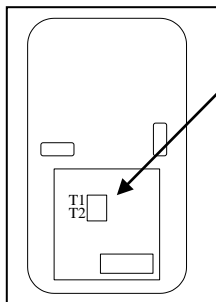

Image No. 7

Attached Probe to T1 & T2

Note

- 1) **Do not Extend or Reduce the length of the probe cable**
- 2) **Sensor design to work with Probe supplied, alternative probes will result in incorrect temperature values.**

8.7 Stat Symbols

8.7.1 Home Owner (Normal Mode) Icons

Home Owner (Normal Mode) Icons

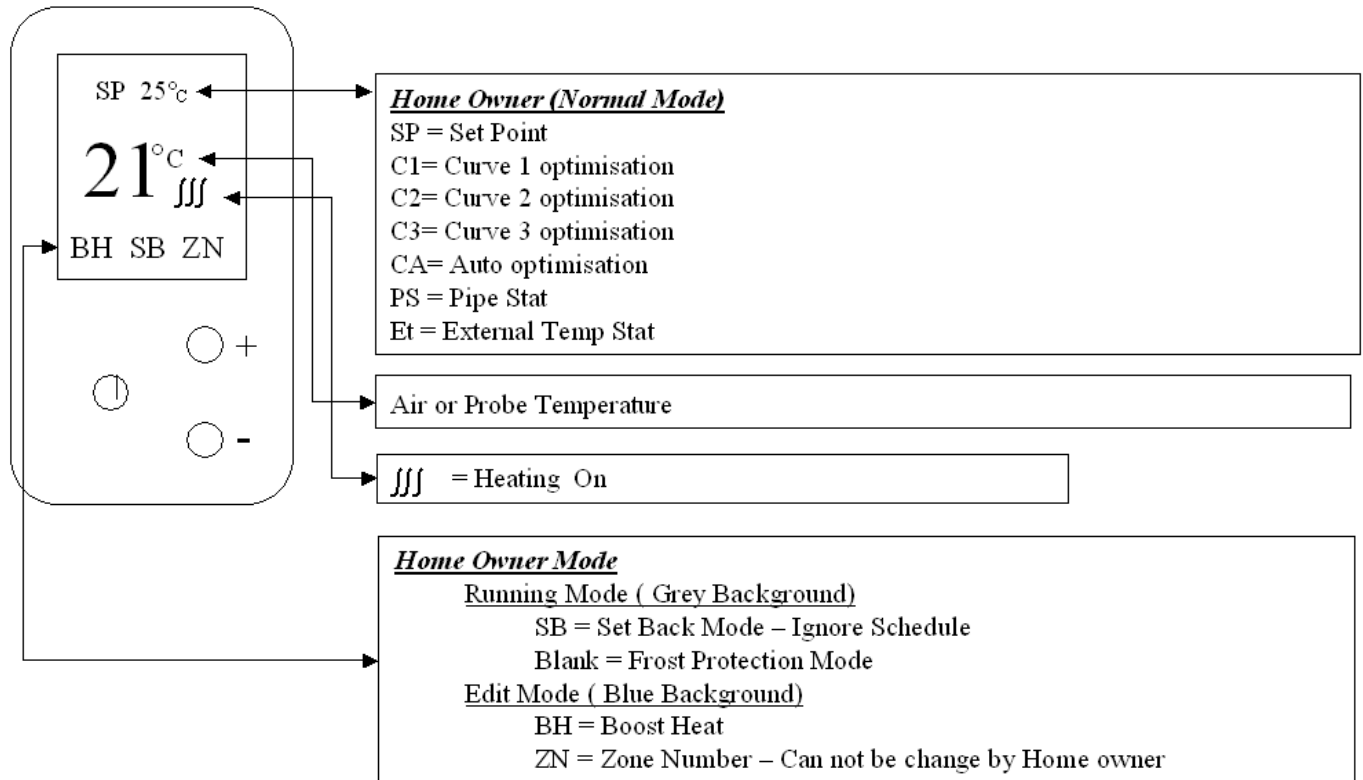



iCon - Intelligent Control for Heating Systems

8.7.2 Stat Symbols - Engineering Mode Icons

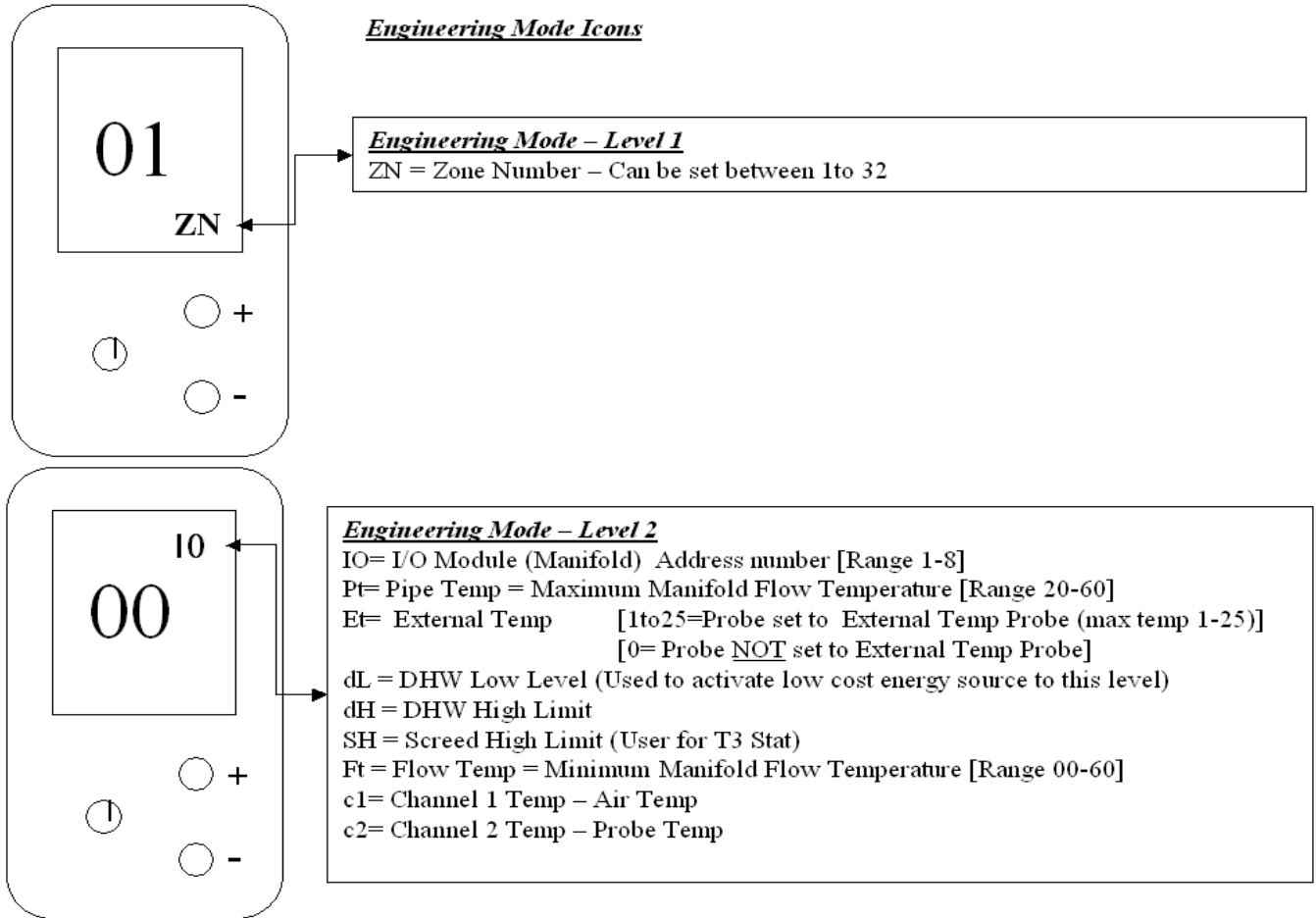





iCon - Intelligent Control for Heating Systems



9. Set Time

Press  key .

Console Displays

Time 09:40
25/02/06 < FRI >

Move brackets press  and .

Change value press  or .

10. Set Service Date

Press  key .

Console Displays

Time 09:40
25/02/06 < FRI >

Press  key



3 Times



Console Displays

Service <09>40
25/02/06

Service Time

Service Date

Move brackets press  and .

Change value press  or .



iCon - Intelligent Control for Heating Systems

11. Vacation Activation

11.1 Setting Vacation Date in Console

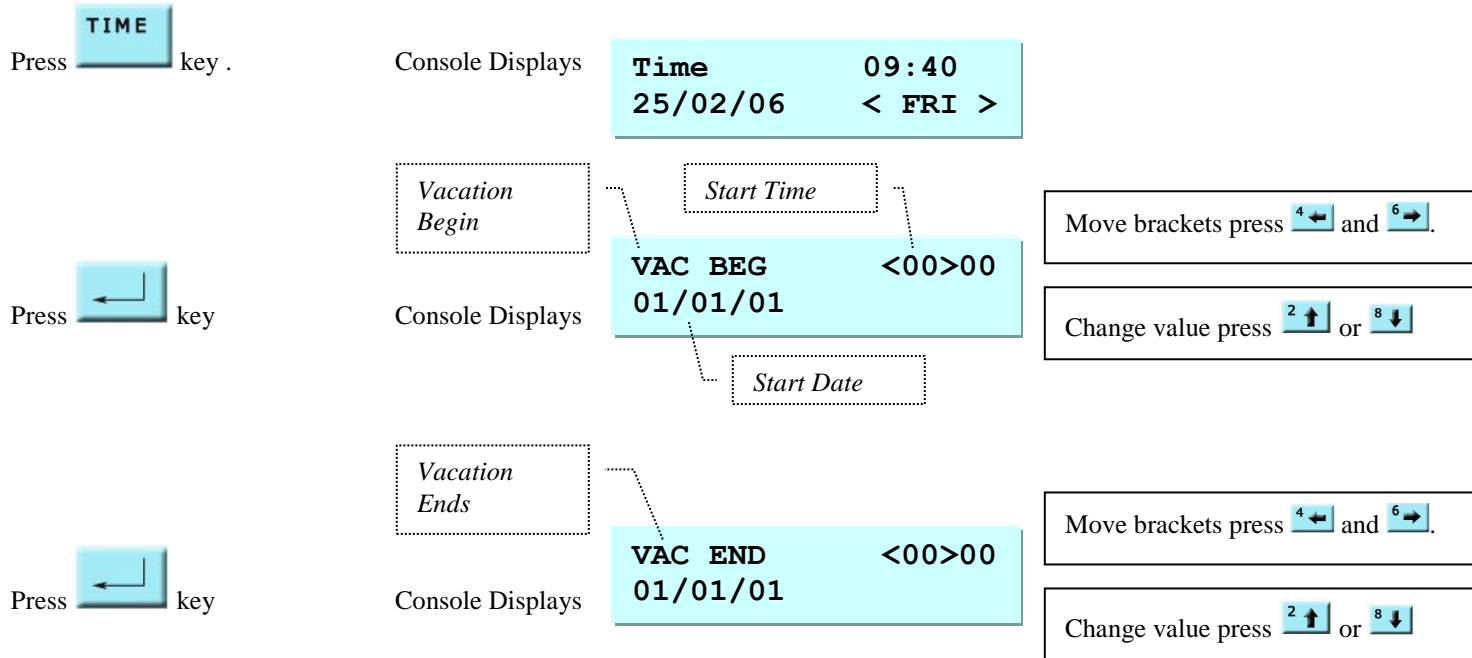

11.2 Activating Vacation Through Phone

Overview:

The system allows a volt free sign to be attached to Input 5 on the 1st logic box and this can be used to activate vacation mode .

In vacation mode all zones will move to Setback and the DHW will be switched off.

As the phone facility is required Input 1:5 (Logic Box 1, Input 5), must be set up for Vacation mode this is activated in the Engineering mode, outlined below.

Access Engineering Mode

Press  &  together.

Enter the Engineering Code **3105** & Press 

Console Displays the following 

While in Engineering Mode – Press 

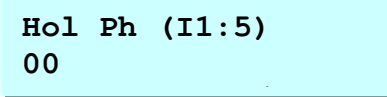
Press  x 3 until  is displayed

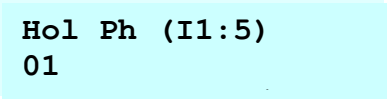
Press 1 to activated –  is displayed

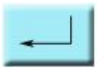
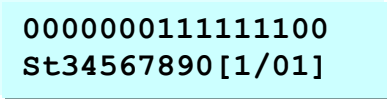
Press  to enter and activated -  is displayed

Wiring Phone Activation

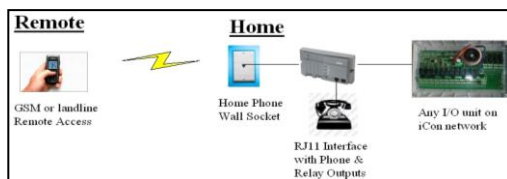

Using a Phone Interface Unit (PIU) , the relay output muts be attached to Input 1:5 (Logic Box 1, Input 5). The relay output from the Phone Interface Unit (PIU) muste be Volt Free.

Operation

Closed Circuit = Normall Operation

Open Circuit = Holiday Mode



iCon - Intelligent Control for Heating Systems

12. Connecting PC to a RS485 Serial Adaptor

Warning: Do Not attached RS485 Adaptor to Logic Box until the adaptor has been Configure (Green Led on Front of Adaptor- Do not attach if Red.)

Overview: An RS485 serial adaptor is required to download the configuration setting from the PC to the Console.

Equipment Required					
Item	Model	Part No	Supplier	Address	Cost
1	2 port USB to RS-422/485 serial adaptor	DSU2-400	Quatech	www.quatech.com	€179
2	3 Core Serial Cable with 9way Connector	CC 100	Comeragh Controls	www.comeraghcontrols.com	€28

Step 1: **Do Not attached RS485 Adaptor to Logic Box until the adaptor has been Configure**
 Connected the RS485 adaptor to your PC USB Port

Step 2. Configure the setting on the PC Port **Model DSU200-300 (2006)**

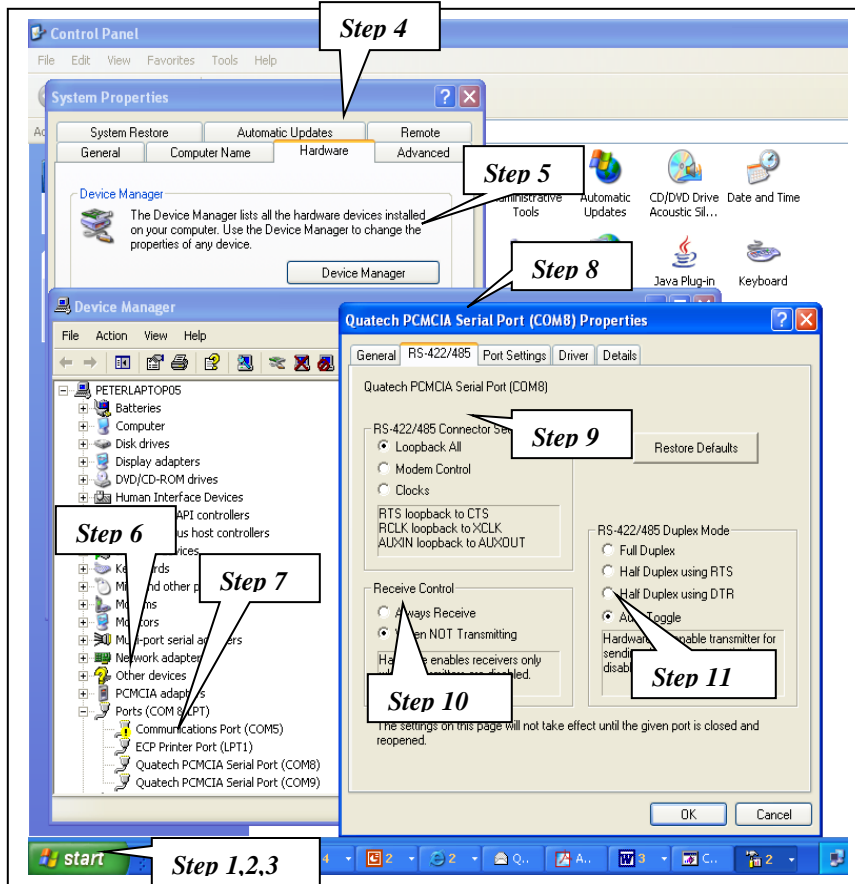

- Steps
1. Click START
 2. Select Control Panel
 3. Select System
 4. Select Hardware
 5. Select Device Manager
 6. Click Ports
 7. Right Click on RS485 attached
 8. Select 5S-422/485 Tab
 9. Set RS422/485 Connectors Setup to Loopback All
 10. Set RS422/485 Receive Control to When NOT Receiving
 11. Set RS422/485 Duplex Mode to Auto Toggle

iCon - Intelligent Control for Heating Systems

Step 2. Configure the setting on the PC Port

Model DSU2-400 (2007)

Step 21. Configure Multi Port Serial Adaptor

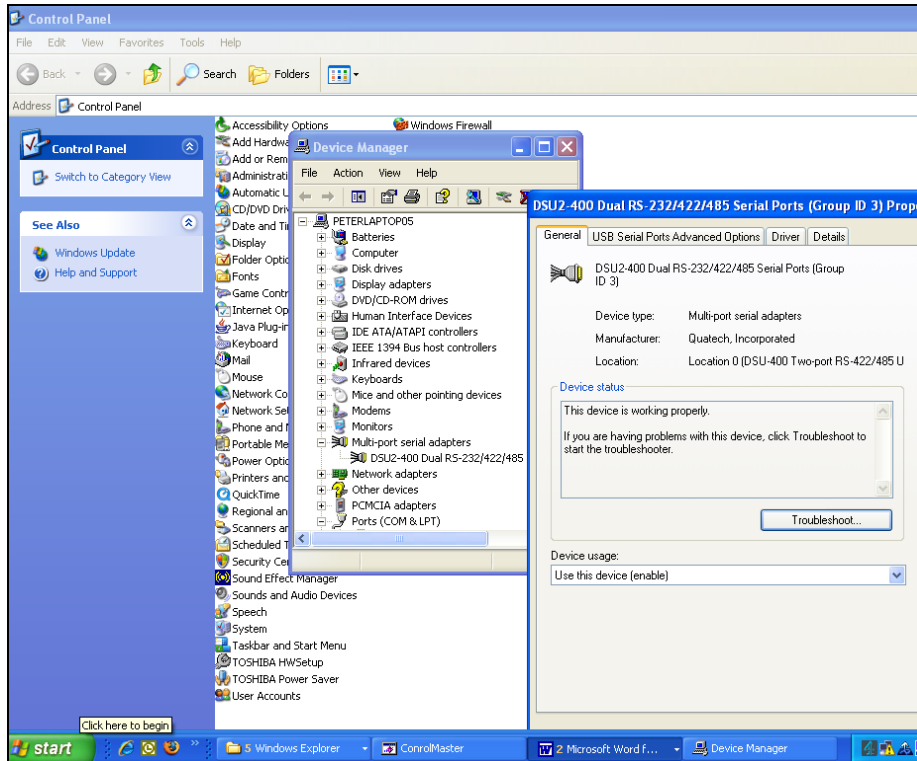

Steps

1. Click START
2. Select Control Panel
3. Select System
4. Select Hardware
5. Select Device Manager
6. Click Multi Port Serial Adaptors
7. Double Left click on DSU2-400Dual RS232/422/485(Serial Port)
8. Select "USB Serial Port Advanced Options" Tab
9. See Setting on following Image

Settings

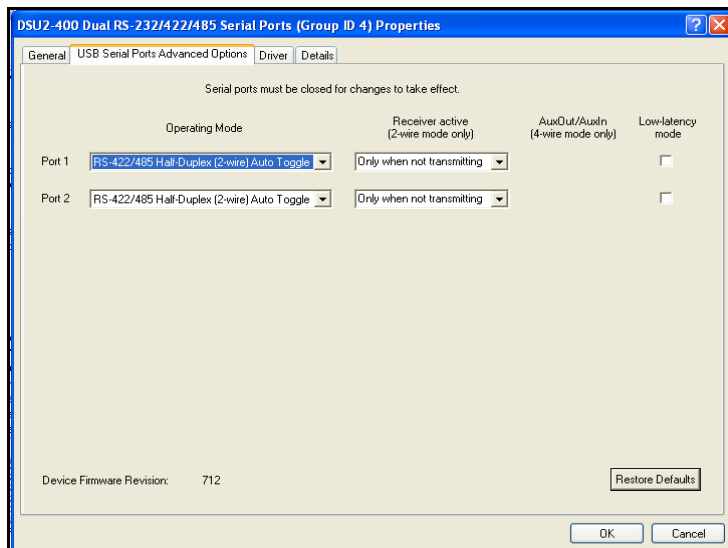



iCon - Intelligent Control for Heating Systems

13. System Download

The download window places the system into a download enable state. System parameters may be transferred from the Control Master PC Application to the console. The system will reset when the download has completed.

Connect Cable

Connect PC to Console (via cable provide)

At Console

Step 1 Enter Engineering Mode on Console (See Section 3.1 above)

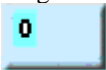

Step 2 Press (Zero) on the console

At PC

Step 1 Select the Port No.

(Your PC will allocate a Port for the RS485 adaptor attached)

(See Section 12: Connecting PC to a RS485 Serial Adaptor - Step 7 will identify the Port Number)

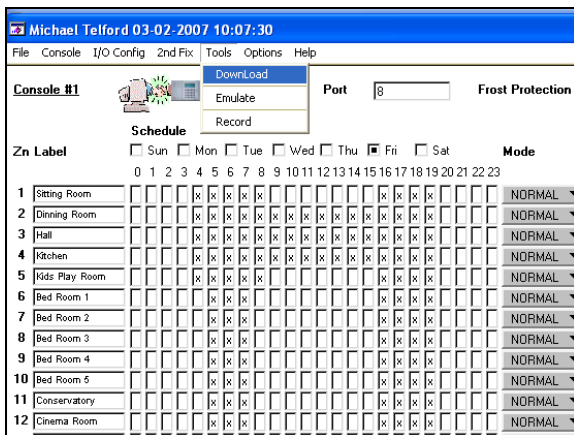

Step 2 Select Tools

Step 3 Select Download

14. System Reset



Press the HOME key to force a system reset.

15. System Erase

The System Erase function erases ALL setup data including zone names, output relay configurations, user password, minimum temperature, frost protection temperature and all TSTAT settings. Press the keys 5, HOME and MODE simultaneously.

IMPORTANT - ALL SETTINGS WILL BE LOST